

STORMWATER INTERCEPTOR  
TYPICAL SYSTEM CONFIGURATION

(SEE NOTE 1)

# JPHV-3000 HIGH VELOCITY STORMWATER INTERCEPTOR

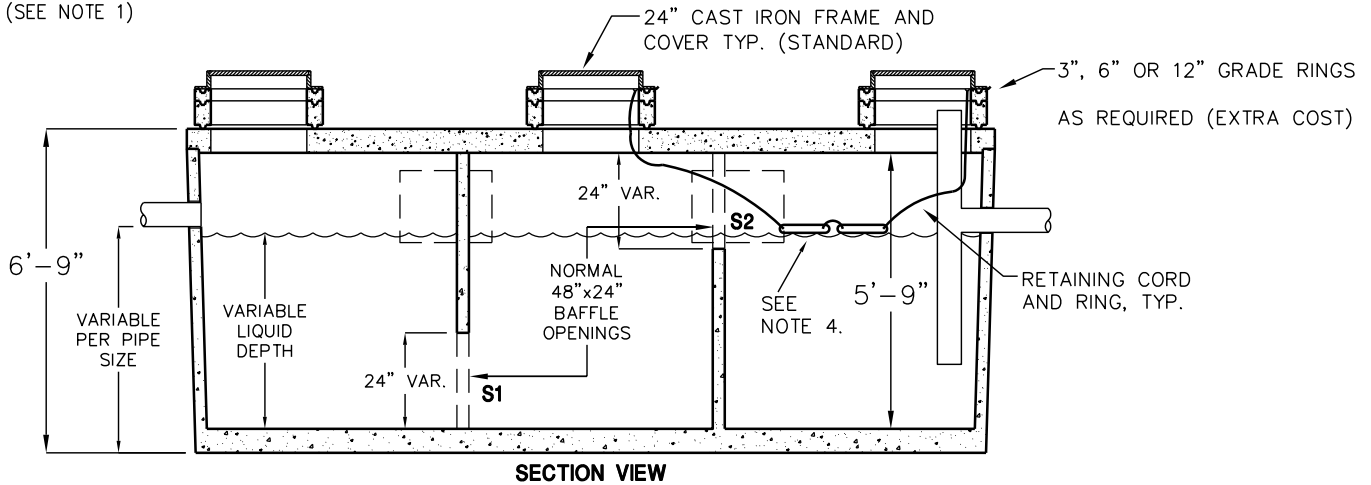

SECTION VIEW

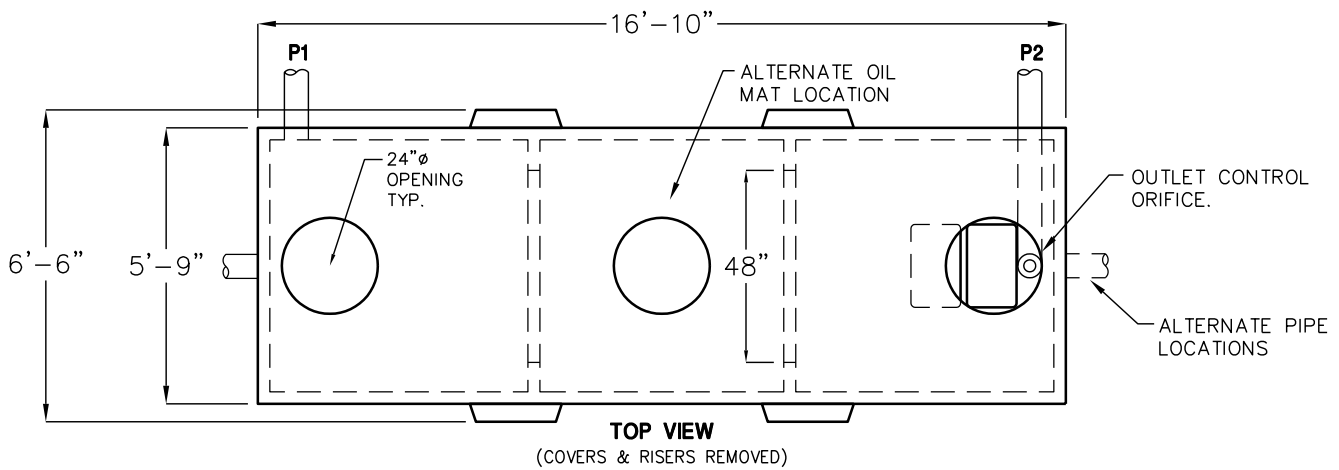

TOP VIEW

(COVERS & RISERS REMOVED)

MODEL JPHV-3000

TOTAL TANK CAPACITY	MAXIMUM TREATMENT FLOW (CFS)	RECOMMENDED TREATMENT FLOW (CFS)	RECOMMENDED OUTLET BOX SIZE	RECOMMENDED MIN. NO. OF SORBENT MATS	TANK ACCESS COVERS REQUIRED
3,483 GAL.	.96	.77	48"Ø ROUND	2	3

NOTES:

1. BYPASS STRUCTURE AND JUNCTION BOX SHALL BE SIZED ACCORDING TO PIPE SIZES AND FLOW. ALTERNATIVE CONFIGURATIONS AVAILABLE, CONTACT JENSEN PRECAST FOR MORE INFORMATION.
2. BAFFLE OPENINGS (S1 & S2) SHALL BE SIZED ACCORDING TO FLOW.
3. ALL EXTERNAL PIPING TO BE SUPPLIED BY OTHERS.
4. OIL SORBENT MATS TO BE EQUIPPED WITH RETAINING CORD AND RING, SECURED TO OR UNDER FRAME AND COVER, FOR HAND ACCESS BY OTHERS.
5. DESIGN LOAD: H-20 TRAFFIC FROM 1' TO 5' OF COVER. FOR OTHER DEPTHS, SPECIAL LOADINGS, AND COMPLETE DESIGN INFORMATION, CONTACT JENSEN PRECAST.
6. MINIMUM GROSS TREATMENT HAZEN'S SURFACE AREA LOADING RATE (SALR) SHALL NOT BE GREATER THAN SIX (6) GALLONS PER MINUTE PER SQUARE FOOT. THE SALR SHALL BE CALCULATED BY DIVIDING THE TREATMENT FREE SURFACE AREA IN SQUARE FEET BY THE DESIGN FLOW RATE IN GALLONS PER MINUTE. NO EXCEPTIONS SHALL BE ALLOWED.