

48" I.D. - PRECAST CONCRETE BASE SHELLS

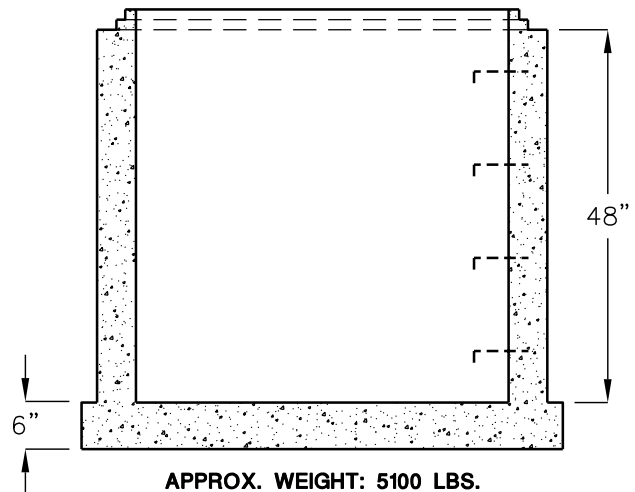
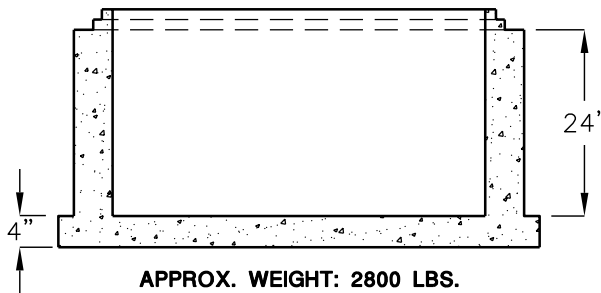
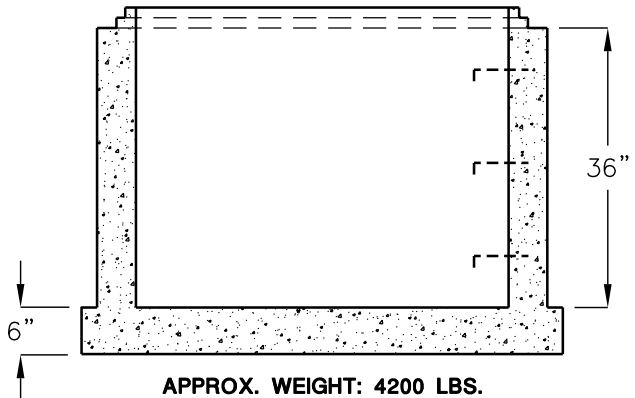
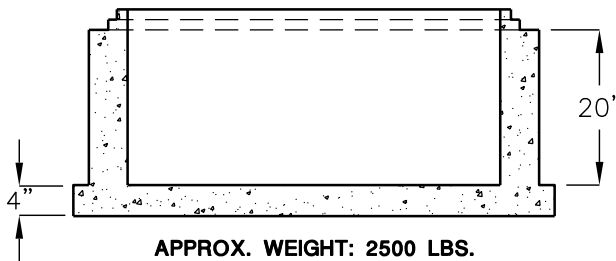
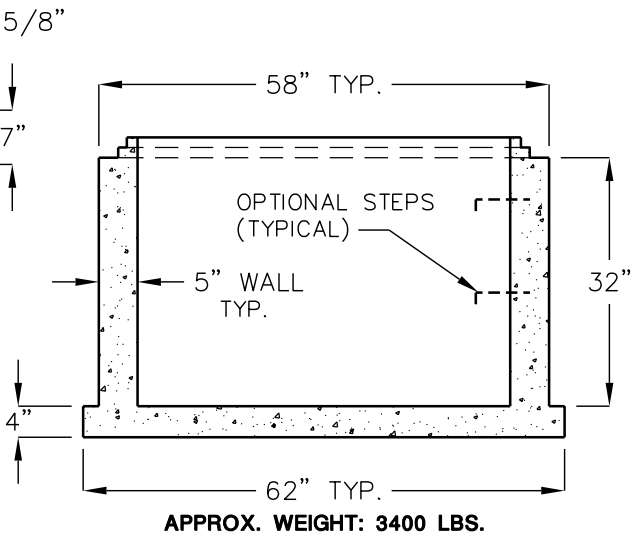
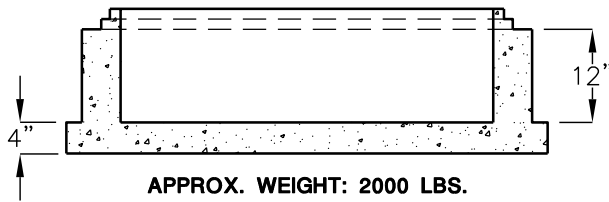
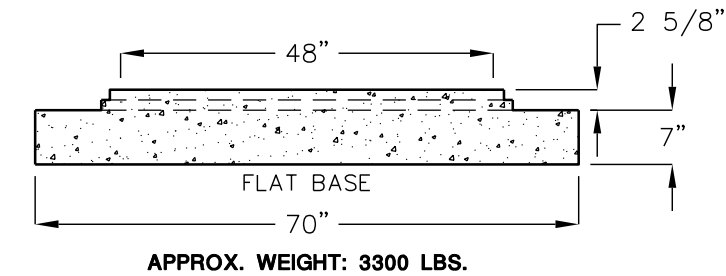

MANHOLE COMPONENTS CONFORM TO CURRENT SPECIFICATIONS, ASTM C-478 AND AASHTO M199.

FLAT TOPS AND BASE SLABS ARE DESIGNED FOR AASHTO HS-20 WHEEL LOADING FOR COMPLETE DESIGN AND PRODUCT INFORMATION, CONTACT JENSEN PRECAST.

AVAILABLE WITH A-LOK RESILIENT PIPE TO MANHOLE CONNECTORS AND PRECAST CHANNELS.