

DROP INLET

30"x30" I.D.
(NOMINAL DIMENSIONS)
WITH FRAME AND GRATE

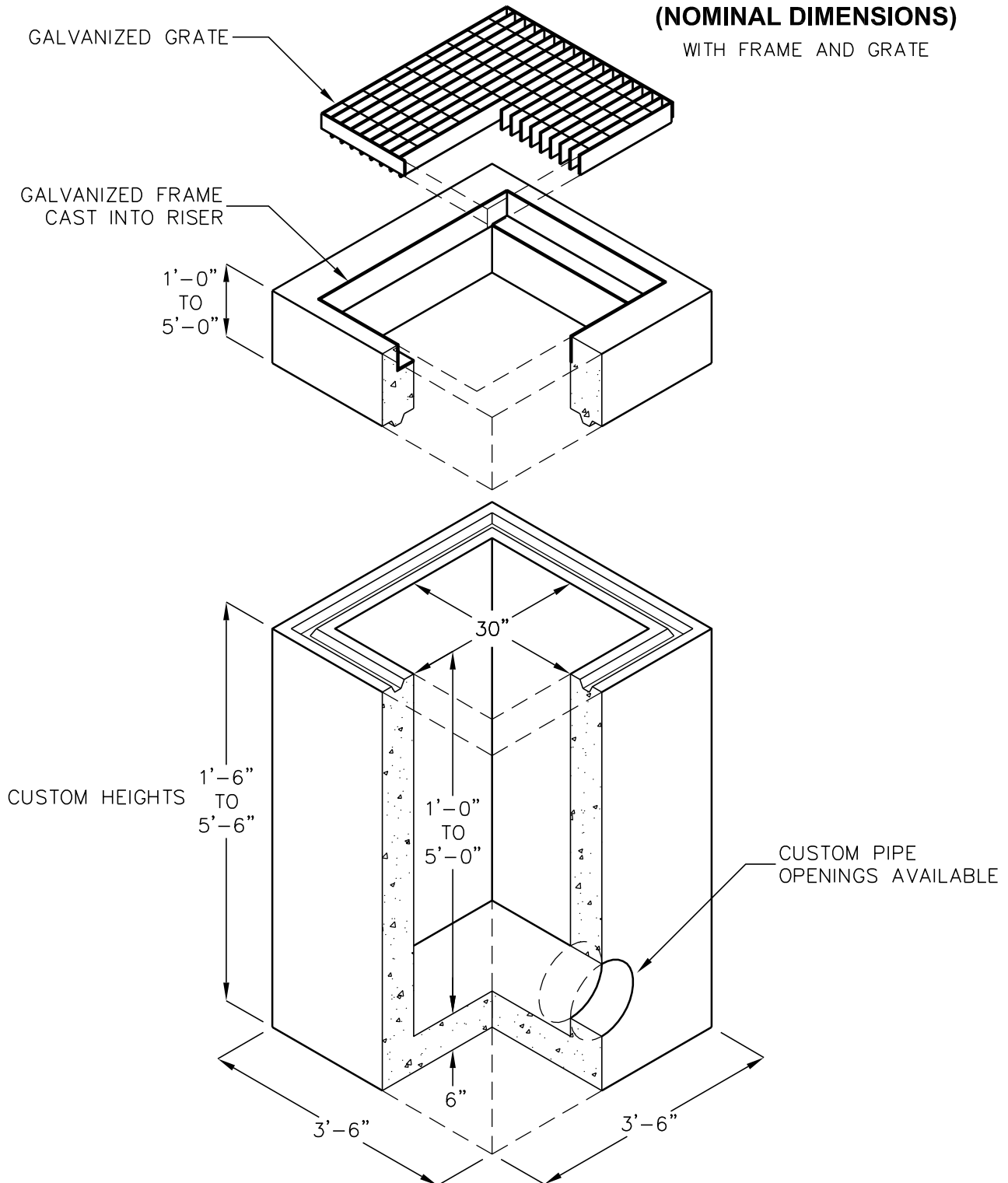

FOR COMPLETE DESIGN AND PRODUCT INFORMATION
CONTACT JENSEN PRECAST.