

24" FRAME AND COVER

MODEL STD 828

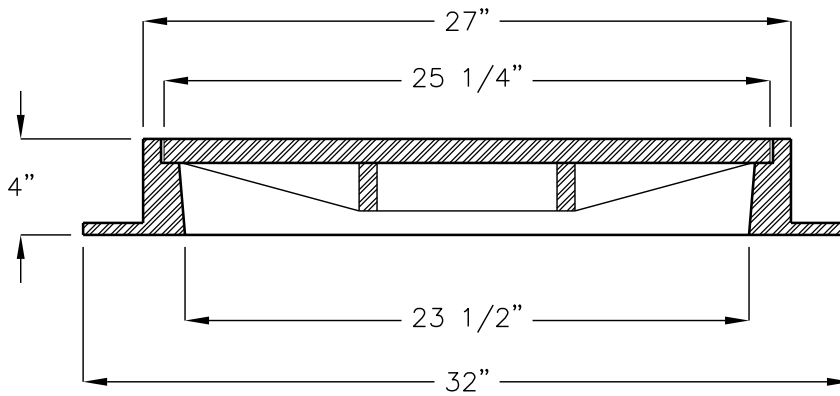
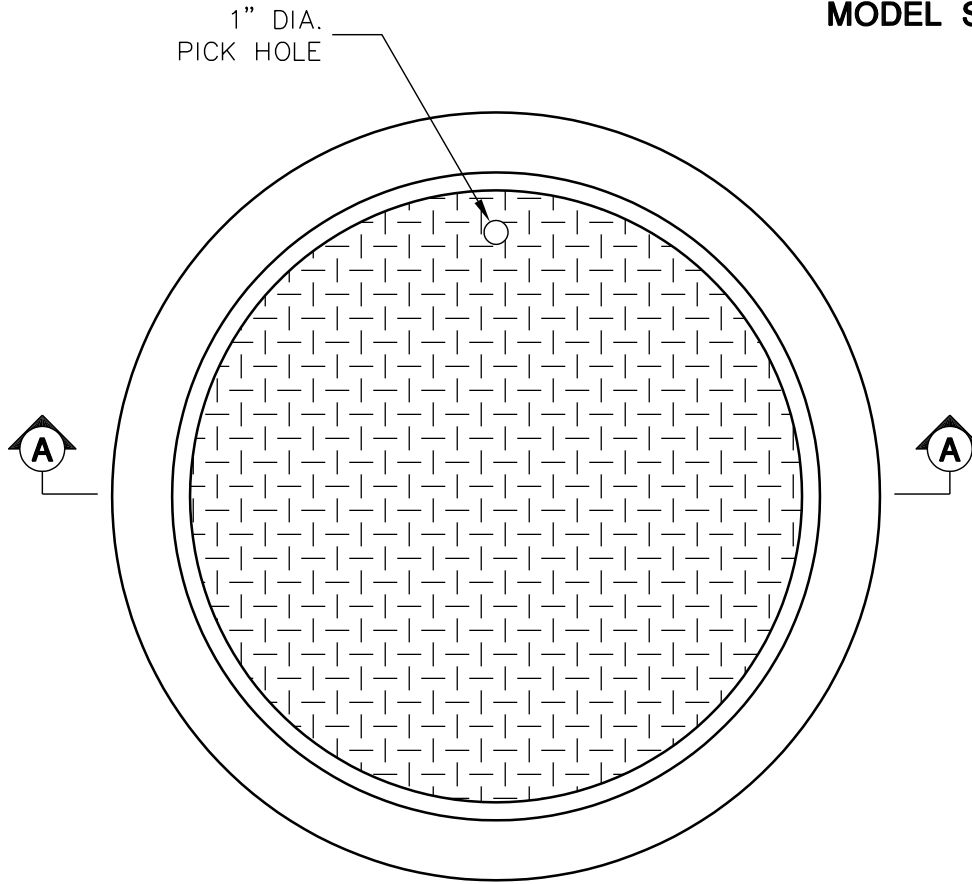

SECTION A-A

FOR COMPLETE DESIGN
AND PRODUCT INFORMATION
CONTACT JENSEN PRECAST.