

JP-1500 GALLON COMMERCIAL SEPTIC TANK

TRAFFIC RATED
ACCEPTED BY UPC®

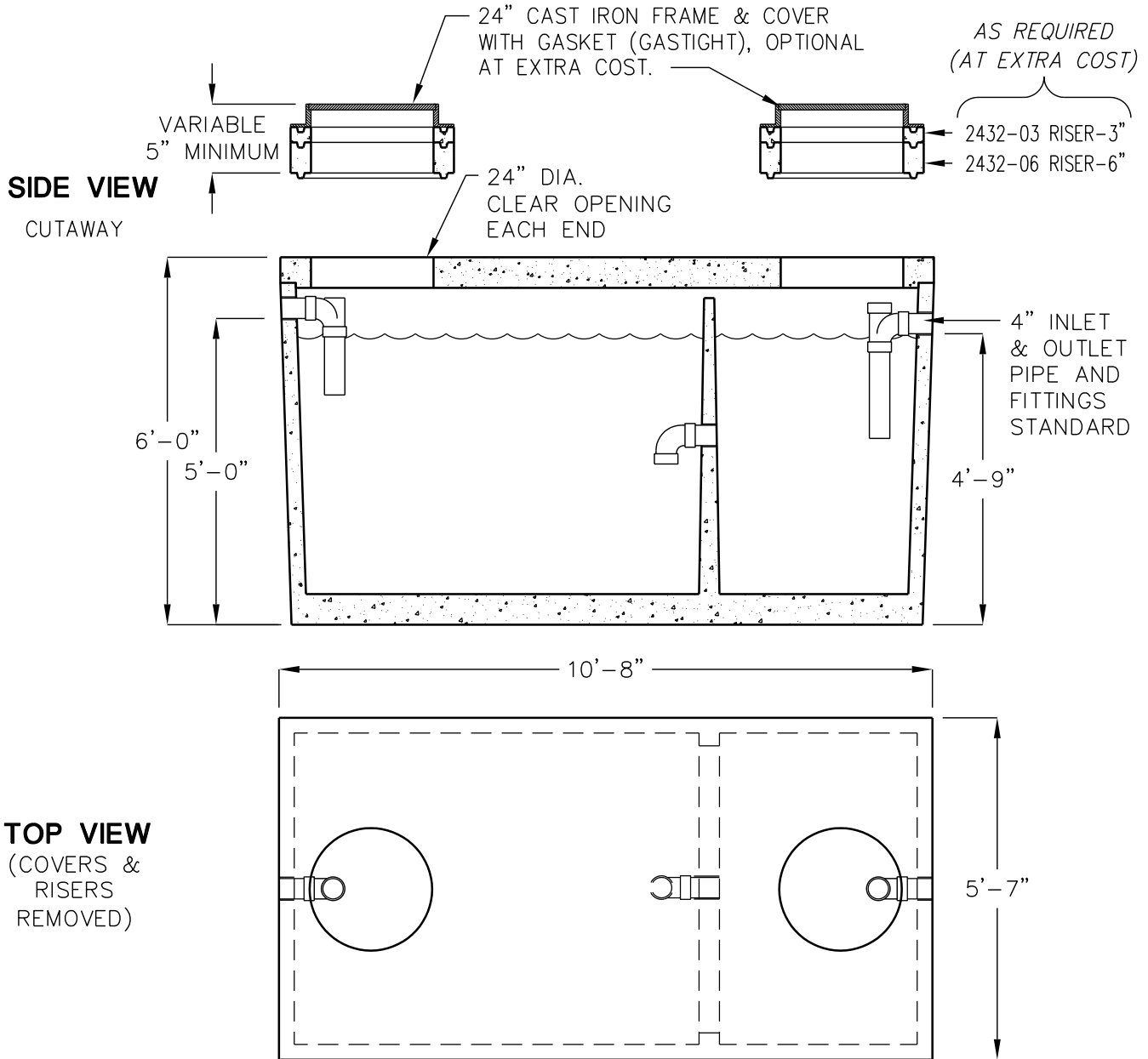

LIQUID CAPACITY: 1,500 GALLONS.

BOX DESIGN LOAD: H-20 TRAFFIC FROM
1' TO 6' OF SOIL COVER.

FOR COMPLETE DESIGN AND PRODUCT
INFORMATION CONTACT JENSEN PRECAST.